

INTRODUCTION

The MFJ-434B was designed by contesters and optimized to perform under the toughest operating conditions. You don't need to be a contest superstar to appreciate what the MFJ-434B can do. Even casual operators will discover the MFJ-434B is packed with user-friendly features that make operating, both in and out of contests, more enjoyable and fun. Set it up, and you'll be amazed how quickly it becomes part of your operating routine.

Before you begin, please read this manual thoroughly. It contains important information you'll need to know before attempting to interface the MFJ-434B with your transceiver. We'll start with a brief introduction to the special features that make your Voice Keyer an important addition to any station, and an absolute necessity for any serious contest station:

Easy Selection: Large soft-touch switches select up to five pre-recorded messages.

Big Memory: Up to 75 seconds accumulated storage.

Dual Front Panel Microphone Connectors: Connect an 8 pin round or RJ-45 modular connector equipped microphone.

Endless-Loop Timer: Convenient front panel controls adjust repeat-message interval of 0.5-50 seconds or 5-500 seconds. Timing cycle begins at the end of your message.

Built-in Mic Interface: Internal jumpers for connection to transceivers including Yaesu, Icom, and Kenwood/Alinco radios.

Automatic Message Stop: Microphone PTT switch automatically halts outgoing messages.

Manual Message Stop: Prominent red *STOP* button halts outgoing messages.

Built-in Amplifier/Speaker: Monitors outgoing messages and previews stored messages.

Two Microphone Sources: Record from your station microphone for seamless audio continuity, or use the built-in electret microphone.

External Microphone Power Select: Adjust internal jumpers to select the proper microphone power level appropriate for your external microphone.

Off-Air Recording: Capture signals from your receiver's audio jack for review or replay.

RFI Proof Circuitry: Extensive suppression and line isolation virtually eliminates RF feedback, hum, and distortion. Isolation transformer prevents mic circuit ground loops.

Dual-Level Gain: Spreads adjustment range for more precise mic gain settings.

Transparent Audio: Keyer electronics won't color your station's normal audio quality.

User-Friendly Panel: Intuitive controls for easy operation under pressure.

External Control: Fully buffered TTL or CMOS level control lines available at rear panel for external PC or remote control interface. Works with popular logging programs like CT or NA.

Power Flexibility: Power from external filtered 9-15 Vdc external source, or power temporarily with internal 9V battery.

Rugged Construction: Tough all aluminum cabinet and surface mount construction means DX-pedition survivability, RF immunity, and years of reliable operation.

Once again, this manual contains important technical information and operating instructions you'll need to know before using your keyer. Please read it thoroughly, and enjoy operating to the fullest!

POWERING YOUR MFJ-434B

Important Note: We recommend turning your radio on *before* powering up the voice keyer. When some transceivers are turned off, the PTT line may be held low. This might cause the keyer to boot up improperly and enter the self-test mode.

External Power: Use any well filtered power source capable of supplying 9-15 Vdc @100 mA (minimum operating voltage is 8 Vdc under full load, sources exceeding 16 Vdc may permanently damage this product). The keyer's external power jack accepts a standard 2.1mm coaxial power plug (spares are available from Radio Shack). *The power plug's center pin must be positive (+) and ground-isolated.* The outer shell is negative (-) and may be grounded or floated at the supply. When connecting to a high current (more than one ampere) supply, we strongly recommend fuse protecting both positive and negative supply leads with ½ ampere to 1 ampere fast-blow fuses.

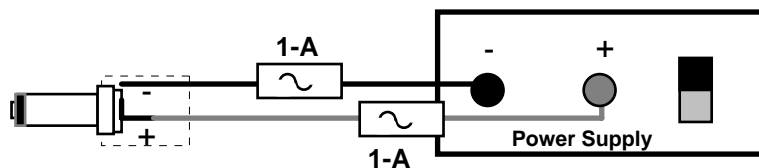

WARNING: Never insert the power plug with power applied—an accidental short from (+) to chassis ground may result. Also, never allow keyer supply voltage to exceed 16 Vdc. Connections to high current power sources must be fuse protected!

MFJ-1312B Power Supply: The MFJ-1312B wall adapter is also suitable for powering your voice keyer. It comes with a 2.1mm power plug pre-installed, and is available directly from MFJ or through your local MFJ dealer.

Internal Power: Use any fresh 9-volt battery for this application. Because current drain is relatively high (15 mA on idle and 65 mA on transmit), battery life is typically quite short. Continuous or prolonged operation on internal battery power is not recommended.

Important Note: MFJ does not recommend powering your unit with a 9-volt battery unless a suitable external supply is unavailable. To install the internal 9-volt battery, remove the keyer's cover and locate the battery snap inside. Note the plastic insulating sleeve covering the snap terminals—this sleeve prevents the contacts from shorting to the case or other components. Slip the sleeve *down onto the wires* so it won't become misplaced, and install the battery. Mount the battery in its retainer on the back panel.

IMPORTANT WARNING: Remove the 9-volt battery when storing the keyer for extended periods. Remember to reinstall the insulating sleeve on the snap clip.

CONNECTING AND OPERATING THE MFJ-434B

Front Panel:

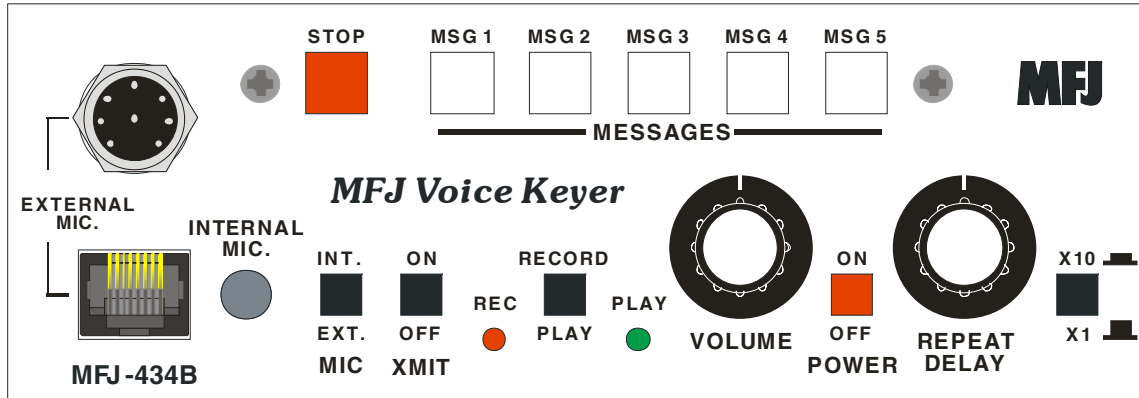

- External Mic Jacks** Plugs for 8 pin round or modular microphone connectors
- Internal Mic** Built-in electret microphone location
- Mic Int./Ext.** Selects internal (in), or external (out) microphone
- Xmit On/Off** Disables transmitter PTT line when reviewing messages
- Record (LED)** Illuminates in record mode, flashes during recording (red)
- Record/Play** Selects record mode (in), or play mode (out)
- Play LED** Illuminates when selector is in play mode (green)
- Volume** Controls volume of monitor speaker (and audio out jack)
- Power On/Off** Main power switch--on (in), off (out)
- Repeat Delay** Varies message-repeat interval (0.5-50 secs or 5-500 secs)
- X1/X10** Multiplies message-repeat interval by x1 (out) or x10 (in)
- Stop** Halts message, cancels endless-loop function
- Messages** Selects message slots 1-5 and starts record or playback

Rear Panel:

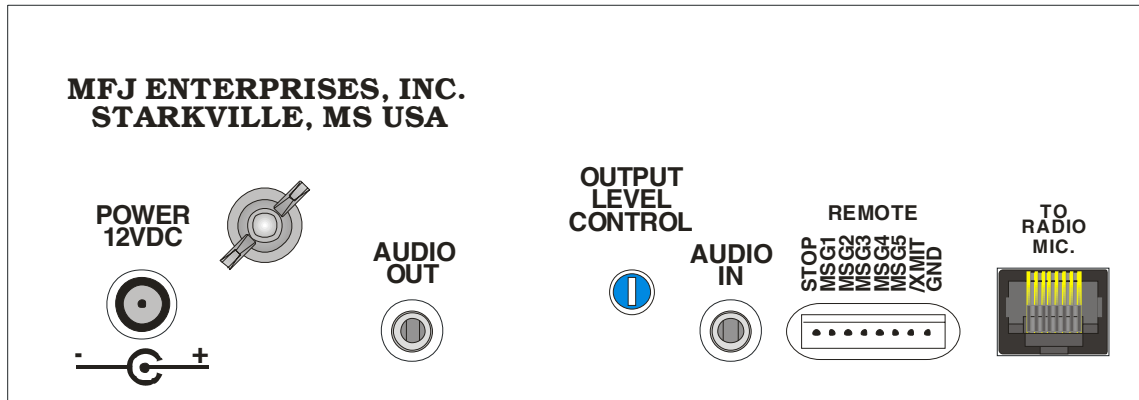

Power	Requires 9-16 Vdc @ 100mA
Audio Out	Monitor audio output, ~500 mW max
Output Level Control	Adjusts microphone output level to radio
Audio In	600 Ohm input jack for recording external signals
Remote Port	Remote access to messages and transmit busy lines
To Radio Mic	Audio/PTT (RJ-45) output for radio's microphone input
Ground	Ground terminal to station's ground buss

Microphone Connections

IMPORTANT WARNING: Never connect more than one microphone at once to the the MFJ-434B. Damage may occur to the voice keyer or other connected equipment.

The MFJ-434B comes with a standard 8 pin round microphone connector and a RJ-45 modular connector located on the front panel. These are the same types used by most transceiver manufacturers. Since manufacturers wire these 8 pin connectors differently, the MFJ-434B provides a convenient jumper interface to program its connectors for use with different transceivers. This feature eliminates the need for re-wiring jacks or adding adapter cables. At the MFJ factory, the interface is set for Yaesu transceivers with **modular** microphone connectors (FT-817, FT-857, FT-897). If you operate one of these Yaesu transceivers, you may disregard this section and use your keyer without resetting the interface jumpers. Jumper configurations for other Yaesu radios are also located in the appendix. If you use a radio made by a different manufacturer, or different connector refer to the section below.

An internal jumper (J6) selects *external microphone voltage*. Some microphones require external voltage to operate. This jumper supplies 0, 1.5, 5, or 8 volts.

IMPORTANT WARNING: The MFJ-434B's internal jumpers are factory set for compatibility with Yaesu transceivers (FT-817, FT-857, FT-897) using conventional dynamic or crystal microphones. When using Icom or Kenwood/Alinco products, internal jumpers must be reset for the correct manufacturer and microphone voltage.

Microphone Jumper Configuration (Icom, Kenwood, Yaesu)

1. Disconnect any 12VDC source from the MFJ-434B.
2. Next remove the screws from the sides and top of the voice keyer enclosure. Remove the cover, being careful not to stress the monitor speaker wires.
3. Use Appendix A at the end of this manual to locate the jumper configuration specific to your Icom, Kenwood, or Yaesu radio. If your radio is not included in the appendix use the section below titled **Microphone Jumper Configurations (Other Radios)**.
4. **JMP2-9:** On the left side of the circuit board, locate the set of headers JMP2-9. There are 8 possible configurations on each row of jumpers 2-9. See the jumper diagram below.

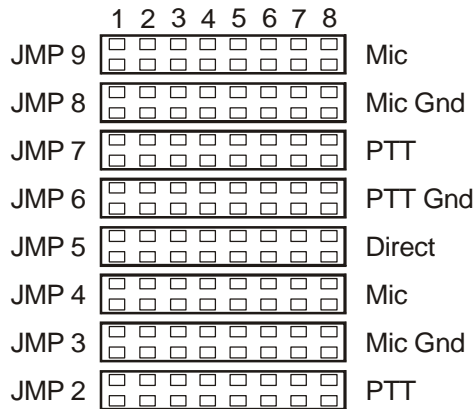

5. Remove the jumpers on JMP2-9 ONLY.
6. Replace the jumpers on JMP2-9 using the diagram specific to your radio located in the Appendix of this manual. If your radio is not listed use the following section for determining the jumper settings for other radios.
7. Replace the cover and screws when you have completed the configuration.

Microphone Jumper Configuration (Other Radios)

1. If your radio is not included in the appendix, the MFJ-434B can be configured by obtaining a copy of the wiring diagram specific to your radio microphone.
2. Use the microphone wiring diagram to determine which microphone pins are used for PTT, PTT Gnd, Mic, Mic Gnd. The front panel view of the microphone connectors below can be used to determine how the pins will need to be configured.

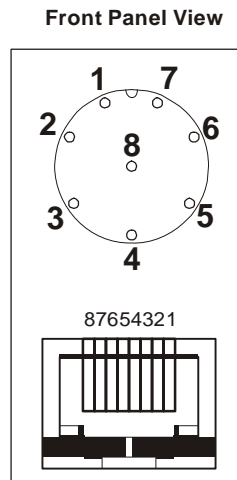

3. **JMP4 and JMP9 (Mic):** Place jmp 4 and jmp 9 on the corresponding pin number required by your microphone. This pin number can be determined from the front panel view above. For example if your radio has Mic input on pin 1 a jumper will be placed on jmp9 pin 1 and jmp4 pin 1.
4. **JMP3 and JMP8 (Mic Gnd):** Place jmp 3 and jmp 8 on the pin number required by your microphone. This pin number can be determined from the front panel view above. For example if your radio has Mic Gnd on pin 7 a jumper will be placed on jmp3 pin 7 and jmp8 pin 7.
5. **JMP2 and JMP7 (PTT):** Place jmp 2 and jmp 7 on the pin number required by your microphone. This pin number can be determined from the front panel view above. For example if your radio has Mic Gnd on pin 5 a jumper will be placed on jmp2 pin 5 and jmp7 pin 5.
6. **JMP5 and JMP6 (PTT GND):** This is often referred to as Ground in some radio manuals. Place jmp 5 and jmp 6 on the pin number required by your microphone configuration. This pin number can be determined from the front panel view above. For example if your radio has PTT Grnd on pin 6 a jumper will be placed on jmp5 pin 6 and jmp6 pin 6.
7. **JMP5 (Direct):** Place jumpers on jmp5 (direct) on remaining lines not configured above. These pins will control up/dn, +VDC, squelch, AF, and other functions commonly found on transceivers. By placing a jumper on jmp5 the MFJ-434B circuit is by-passed on the corresponding pins.
8. **JMP6 (Mic Voltage):** There are four jumper pins near the front of the circuit board (to the rear of the green LED), labeled JMP6 with 8V, 5V, 1.5V, and 0V markings. This jumper is normally set at 0V, which is compatible with Yaesu and other standard dynamic and crystal microphones that do not require external voltage. If you are using a microphone that does require external voltage, or if your microphone does not record to the voice keyer but works normally when connected to the voice keyer, consult the specifications for your microphone. Place the jumpers in the setting that most closely matches the voltage specified by your microphone manufacturer.

IMPORTANT WARNING: Do not inadvertently change the jumper on HD1. This jumper is set on pins 7-8 and should not be moved.

Other Internal Adjustments

Please note two other important internal settings while the cover is off and the pc board visible:

1. **Dual Gain Control, R29:** This trimpot, located next to the audio isolation transformer, sets the overall adjustment range of the *Output Level Control* located on the rear panel. If you find the back panel gain control must be adjusted to an extreme setting (high or low) to provide the correct levels to your radio, you may reset R29 to bring the *Output Level Control* back into its center range.
2. **PTT Automatic Override, JMP1:** This jumper plug enables the *Automatic Override* feature that stops outgoing messages whenever the PTT switch is pressed. When the plug is removed, the automatic override function is disabled.

Audio Lines

Audio In: This 3.5mm jack accepts audio signals from a receiver or other low impedance monaural source for recording. Maximum input level is 0 dBm at 600 Ohms (2 Vpp), and the minimum usable level is -23 dBm into 600 Ohms (0.15 Vpp). Inserting a plug automatically disconnects the keyer's internal electret mic. Both jack terminals float with respect to ground to permit connecting balanced or unbalanced sources. If you experience station microphone hum with an external audio source plugged in, install a 600 Ohm 1:1 audio isolation transformer in the external audio line (RadioShack RS273-1374). All audio lines, balanced or unbalanced, should be grounded at one end only.

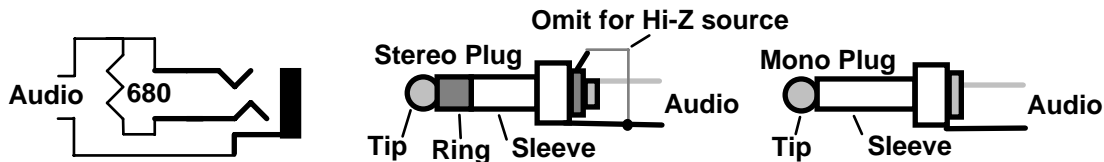

IMPORTANT WARNING: Never exceed 3 Vdc or 3 Vpp input on the "Audio In" jack. If recorded audio is distorted, either reduce the external audio level control or add external attenuation to reduce level. When using stereo plugs, connect the ring terminal to the sleeve for 600-Ohm lines, or leave open for hi-Z audio sources.

Audio Out: This 3.5mm jack provides a low impedance monaural output signal from the keyer's monitor amplifier, disconnecting the internal speaker when a plug is inserted. Output is unbalanced, and the monitor amplifier delivers a maximum undistorted signal level of approximately 4Vpp into 4 ohms (or about 500 mW RMS). The jack's tip lead is "hot" and the sleeve is connected to both signal and chassis ground. When using stereo plugs, do not wire to the ring terminal (see input jack diagram above). Note that stereo headphones will not function properly when plugged into this jack.

Remote Port Connections

Remote message control lines are provided at the back panel via a male 8-pin IDC plug. This provides individual access to all five memory lines (*MSG1-MSG5*) plus the stop message line (*Stop*). All lines are isolated by a buffer, and are CMOS and TTL level compatible.

A special output line provides 12 Vdc at low current when the voice keyer is not transmitting. This line goes logic low when the keyer transmits (*Xmit*), and can sink more than 20 mA. Another pin provides a control voltage ground (*Gnd*), for the control system return path.

These lines are clearly labeled on the back panel for your convenience. The Remote Port IDC connector may be used to add a remote control box or to provide an interface point for PC driven message activation. Instructions for constructing a simple remote control switch box and an external PC interface are provided later in the manual.

Initial Setup

Before powering up your voice keyer, double-check all connections to your transceiver, microphone, etc. Be especially certain the power source is wired properly and delivering 9-15 Vdc with the center pin positive, and that the supply can handle at least 100 mA. If the supply is larger than 1 ampere, be sure you fuse the positive and negative lines. Pre-set your keyer's controls as follows:

Mic Int./Ext: Set as needed--*Int* for built-in mic or *Ext* for station's PTT mic.

Xmit: *Off* (out).

Rec/Play: *Play* (out).

Volume: 10 o'clock position.

Power: *Off* (out). Remember to power your transceiver *before* turning on the keyer.

Repeat Delay: Fully counter-clockwise (CW) for minimum delay.

X10/X1: *X1* (out).

Recording A Message

- 1. Press *POWER* to *ON*:** The green *Play* LED should illuminate.
- 2. Press *REC/PLAY* switch to *REC*:** The red *Rec* LED should illuminate and the green *Play* LED should extinguish.
- 3. Choose Audio Source:** Audio is available for recording from three sources--the internal mic, external station mic, and line level *Audio In* jack. Select as follows:
 - A. Built-In Electret Mic:** Set *Mic* switch to *Int* and speak normally about one foot away from the front panel. Don't crowd the mic element, or distortion may result. Note that installing a plug into the *Audio In* jack *disables* the electret mic. Remove any plug connected to the *Audio In* jack before attempting to use the internal mic.
 - B. Station Mic:** Set the *Mic* switch to *Ext* and speak normally. Most station mics will not require PTT activation to record. However, mics with switched audio lines will. In this event, it's okay to press the PTT switch and speak (your radio will key up, but no audio will be sent out over the air). If PTT keying poses a problem, disconnect the voice keyer cable from your radio until recording is completed.

- C. **Off-Air or External Audio Source:** Set *Mic* switch to *Int* and plug a line level audio source into the *Audio In* jack on the rear panel. Installing a plug in the *Audio In* jack disables the electret mic. Line level sources should not exceed 0-dBm.
- 4. **Select A Message Slot:** Choose from *MSG1-MSG5* on the front panel. Press your selection and watch the *Rec* LED (it should flash within about two seconds). The first flash indicates recording has begun. To avoid recording "dead air", begin speaking the moment the red *Rec* LED starts flashing.
- 5. **Record Your Message:** The voice memory IC will record for as long as the memory button is held in, but *no longer than the memory's capacity*. The *Rec* LED will begin flashing rapidly to notify you when the memory time in each message block is nearly expired. To conserve memory and prevent accidental over writing, release the memory button immediately after your last word.

Message Memories

The *MSG* storage space is actually one continuous block of memory with start cues inserted at 5 points along its span. These form 5 message slots. To use all 5 slots, each entry must not exceed the times specified below:

<i>MSG1</i>	<i>MSG2</i>	<i>MSG3</i>	<i>MSG4</i>	<i>MSG5</i>
32 Seconds	10 Seconds	10 Seconds	10 Seconds	13 Seconds

The time line chart below illustrates how a series of short recorded messages might be distributed in the memory:

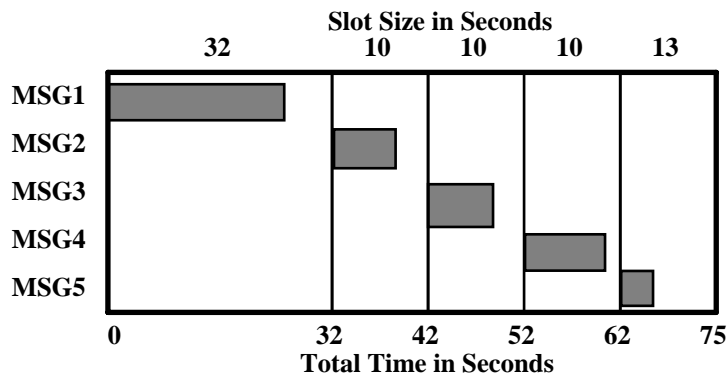

The next chart illustrates a message recorded under *MSG1* that exceeds its allotted 32 second limit. Note that *MSG1* continues to record beyond the partition, purging the previous contents of *MSG2*. When called up, *all of MSG1* will play back without interruption. However, when *MSG2* is called up, only that part of *MSG1* falling in the *MSG2* slot will play.

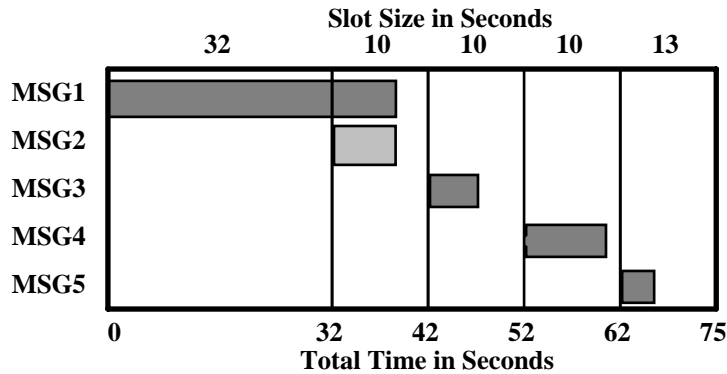

This feature enables you to load up to a 75 second message in *MSG1*, should you need a long recording (progressively fewer slots are available as your message grows in length). When the memory limit is reached, the red *Rec* LED will stop blinking and the record function will stop automatically. With a little practice, you can use this protocol to extend your unit's flexibility.

Message Playback

Until you become fully familiar with your Voice Keyer's operation, we suggest practicing with it disconnected from your transceiver. This will prevent accidental on air interference.

1. **Previewing Recorded Messages:** Whenever the *Xmit* button is *Off* (out), you may select any message (*MSG*) in memory and listen to it on the monitor speaker without transmitting it over the air. Monitor playback level is adjusted via the *Volume* control on the keyer's front panel.
2. **Transmitting Recorded Messages:** Whenever the *Xmit* button is *On* (in), any message (*MSG*) you select *will* be transmitted over the air.
3. **Single Play of a Recorded Message:** To preview or transmit a message one time only, press the desired *MSG* switch *briefly* and release.
4. **Endless Loop Playback of a Recorded Message:** To preview or transmit a message in endless loop mode, *press and hold the desired MSG button for two seconds*--until the green *Play* LED begins blinking. When you release the *MSG* button, the first playback will start. It will then repeat at the interval set by the *Repeat Delay* controls until halted.
5. **Adjusting the Endless Loop Delay Interval:** The repeat interval begins at the end of the recorded message. The front panel knob labeled *Repeat Delay* adjusts the interval from 0.5-50 seconds in the *XI* switch position and from 5-500 seconds in the *XI0* switch position. We recommend checking the interval time in preview mode (*Xmit* switch *Off*) before putting your message on air.
6. **Halting Playback of a Recorded Message:** Any of the following actions will stop message playback immediately:
 - A. Press the red *Stop* button to halt the message in progress.
 - B. Press the PTT switch on your mic to halt the message in progress.

C. Press any other *MSG* button to halt the current message and start a new one.

7. Adjusting the Output Level Control: Before attempting to transmit recordings on air, you must set the *Output Level* control on the back panel for your keyer. Begin by recording a test message into one of the *MSG* memories, being careful to speak at normal levels. Preview this message after recording to make sure it's okay before proceeding.

Note that your transceiver's mic gain *should be set to the position where you normally run it*. The *Output Level* control is then adjusted to match the audio level produced by your station microphone. If possible, use a dummy load during this adjustment procedure to avoid generating needless on-the-air interference.

A. Establish Normal Mic Level: Press the PTT and speak normally into your station mic, noting the average RF output level and ALC reading on the transceiver's meters.

Important Note: Do not readjust transmitter Mic Gain during the following procedure. The Voice Keyer's output level should be set to match the normal output level of your station microphone.

B. Play Message: Make sure the keyer is in *Play* mode, and activate the *Xmit* switch (in). Now, activate your test message by pressing the appropriate *MSG* button. The radio should key automatically when the message begins, and drop out when it stops.

C. Set Output Level Control: Find the *Output Level* screwdriver adjustment on the back panel and adjust it so the transceiver's meter readings approximate those from live speech. If your final adjustment falls in the bottom or top 1/4 of the pot's control range, we recommend resetting R29. To do this, first set the *Output Level* for its 12:00 o'clock (mid range) setting. Then, adjust R29 for the correct transmit level. This adjustment centers the *Output Level* control range, making fine level adjustments easier. See Other Internal Adjustments for more details on locating and setting R29.

Self Test Mode

The MFJ-434 features a self test mode for confirming correct operation. This sequence evaluates several functions, including all *MSG* buttons, remote port functions, LED's, PTT function, repeat delay pot, and delay range switch.

1. To start the self test, release all buttons (out position) and turn the *Repeat Delay* pot fully clockwise. Next, press *Stop* while turning *Power* on.
2. The green LED should send a copyright message and software version number in Morse Code. To skip the copyright message and go straight to test, briefly press and release the *MSG1* button.

3. Press the following buttons in the sequence shown. The green LED should blink once per operation.

STOP → GREEN

MSG1 → GREEN

MSG2 → GREEN

MSG3 → GREEN

MSG4 → GREEN

MSG5 → GREEN

X1/X10 → GREEN

STOP (REMOTE) → GREEN

MSG1 (REMOTE) → GREEN

MSG2 (REMOTE) → GREEN

MSG3 (REMOTE) → GREEN

MSG4 (REMOTE) → GREEN

MSG5 (REMOTE) → GREEN

PTT → GREEN

4. Turn the *Repeat Delay* pot fully counter-clockwise, then fully clockwise. The green LED should blink once at each end of the pot.
5. Press the *Play/Rec* button. The red LED should illuminate.
6. If the unit passes this test, the red LED illuminates steadily. If there is an error, a failure message describing the problem will be sent through the LED using Morse code.

External Control Circuits

Lines available at the *Remote* IDC port permit installing an external remote control switch or PC computer interface. This feature provides external control of voice keyer message buttons *MSG1-MSG5* and *Stop*. In addition, a transmit warning line (*Xmit*) is available to signal external devices when the keyer is activating the transmitter. *Xmit* is a 12 volt signal line sourced through a 10K resistor that goes low during transmit. Each memory control line (*MSG1-MSG5* and *Stop*) is a 5 volt open circuit that must be pulled to within 0.2 volts of ground to reliably activate or halt any message.

Simple Manual Remote Switch

The remote box shown below requires six (6) normally open momentary contact switches, a length of shielded 8 conductor cable, a 8 pin IDC connector, and a small box to hold the switches. The control line ground should be connected *only* at the remote port on the voice

keyer. The shield of the 8 conductor cable is connected to both the switch box chassis and voice keyer chassis. *Do not connect the shield to the signal ground at either end, or erratic operation may result.*

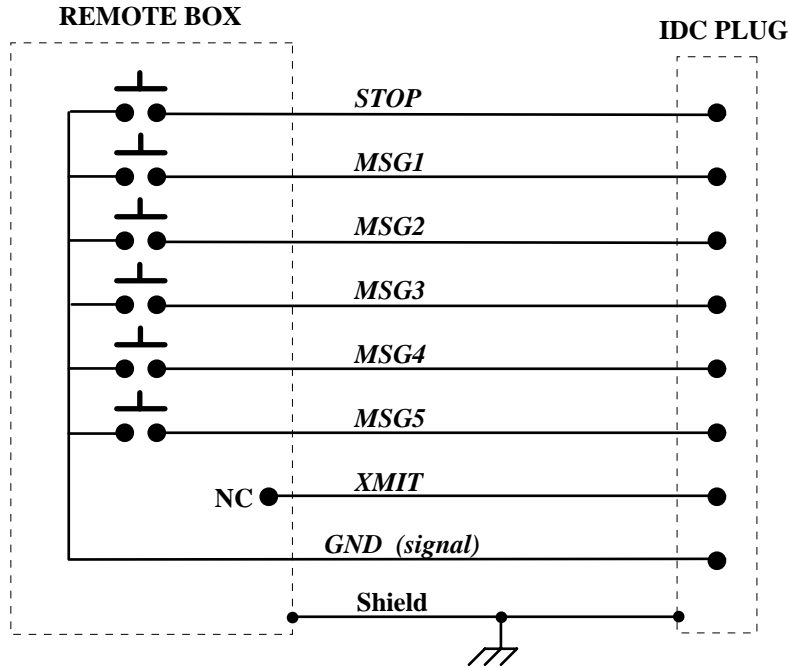

Computer Interface

The MFJ-434 selects memories through a buffered CMOS or TLL compatible interface. While this interface is relatively immune to ground loops (it takes almost 3 V RMS ripple to cause erratic control), it is still a good idea to use careful wiring techniques.

We recommend using the interface circuit shown below to protect the computer from external RF. Each 2N3904 transistor should be driven into saturation for reliable control. This normally requires at least 5 mA of base current.

Locate the driver transistors at the computer, and fully shield all circuitry. Be sure to ground the emitters to the keyer's *signal ground* on the Voice-Keyer' IDC plug only! Keep chassis ground and signal ground separate, or erratic operation may result.

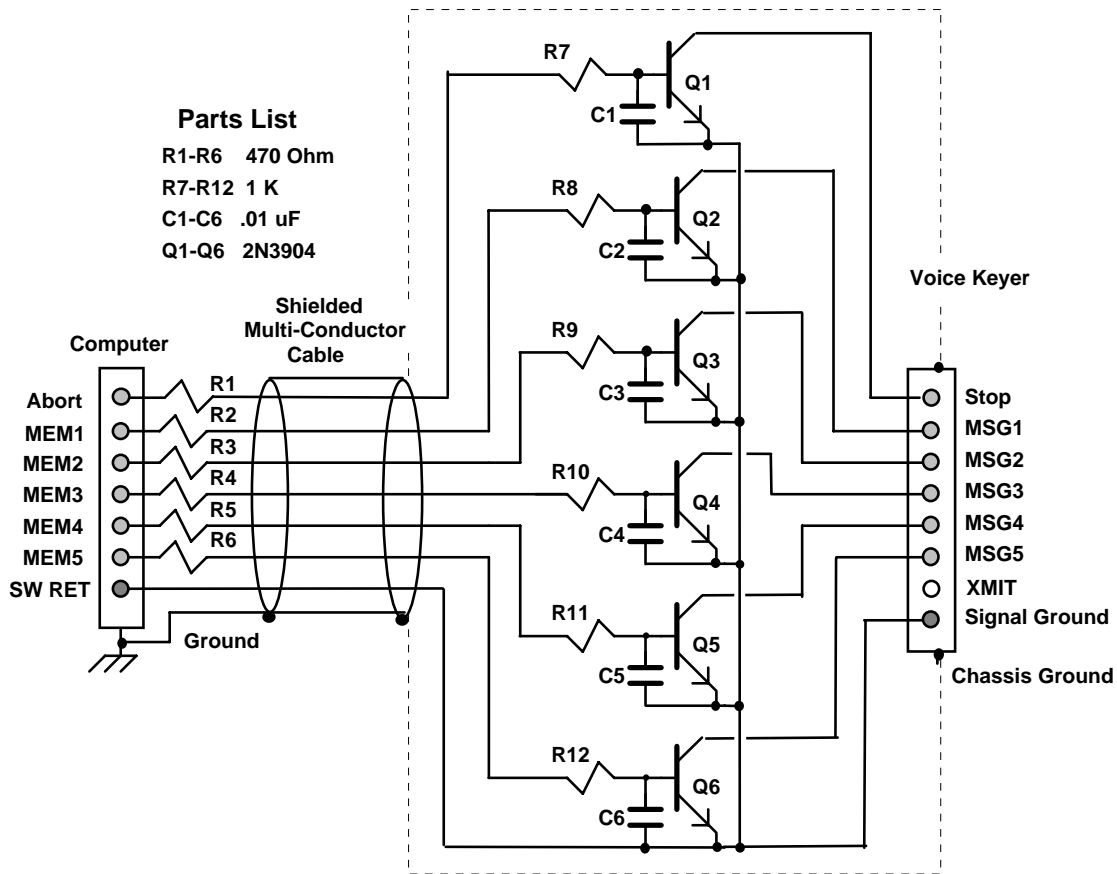

The

following is a cross reference for NA software:

NA	MFJ
ABORT	STOP
MEM (1-5)	MSG (1-5)
SW RET	GND (Control Ground)
GROUND	Shield or Chassis Ground

Trouble Shooting Guide

Keyer Won't Power Up: Check power connections and cables. Also, check the voltage and polarity of your power source--it must be capable of providing 9-15 Vdc @ 100 mA. If running on 9V internal battery, check battery condition.

XMIT Function and Station Mic PTT Function won't work: Check internal microphone jumper interface--does it match the type of transceiver you are using?

Station Mic won't work: Check the External Microphone Power Select. Internal jumpers (JMP6) must be set to the voltage that is closest to that specified by your microphone manufacturer.

Station Mic Won't Record: Press the PTT switch—the mic element may be switched.

Low or Excessive Transmit Audio on Playback: Has the *Output Level Control* been set for the transmitter currently in use? Does internal trimpot R29 need to be reset to bring the *Output Level Control* within the transceiver's drive range?

Distorted Recordings from Audio In Jack: Are levels from your audio source exceeding the keyer's 0-dBm maximum input rating? If so, they must be attenuated.

Weak or Noisy Recordings from Audio In Jack: Are levels from your audio source below the -23 dBm minimum operating level? If so, they must be boosted in some way.

Voice Keyer Won't Activate PTT line on Playback: Check *XMIT* switch position.

Pre-recorded Messages Lost: Were higher numbered message slots accidentally overwritten when recording an excessively long message in a lower numbered slot? Also, check the status of the *REC/PLAY* switch. Was message playback attempted with the switch in *REC* mode? If so, the memories may have been purged by "dead air".

No Monitor Audio: Is a jack plugged into the *Audio Out* connector on back? If so, the internal monitor speaker will be disconnected.

MSG Control Erratic: Check remote jack and any remote control devices attached to it. Was the remote control ground line connected to chassis ground at some point?

PTT Switch Fails to Halt Message Playback: Check JMP1--a shorting plug must be installed for the PTT override function to work.

Hum and Distortion: In ham stations where several pieces of equipment are interconnected, unwanted hum, audio distortion, regeneration, and even sustained AF oscillations may result. This condition *may* be caused by RF feedback, but it's more likely an audio system groundloop (your keyer is heavily protected against RFI). To eliminate RF feedback as the cause, place the transmitter on a dummy load and run tests at full power level. If the audio problem disappears, it's probably RF related. If not, there's probably one or more groundloops in your station setup. Groundloops happen when signal grounds (mic lines, audio output lines, etc) are inadvertently connected to chassis grounds, or when audio patch cables between units are grounded at both ends creating multiple return paths. To solve the problem, begin by looking for multiple ground routes and for interconnected signal and chassis grounds. If eliminating these faults fails to resolve the condition, try installing isolation transformers on problematic audio lines. The more audio related equipment you interconnect, the more careful you have to be!

TECHNICAL ASSISTANCE

If you have any problem with this unit first check the appropriate section of this manual. If the manual does not reference your problem or your problem is not solved by reading the manual, you may call *MFJ Technical Service* at **662-323-0549** or the *MFJ Factory* at **662-323-5869**. You will be best helped if you have your unit, manual and all information on your station handy so you can answer any questions the technicians may ask.

You can also send questions by mail to MFJ Enterprises, Inc., 300 Industrial Park Road, Starkville, MS 39759; by Facsimile (FAX) to 662-323-6551; or by email to techinfo@mfjenterprises.com. Send a complete description of your problem, an explanation of exactly how you are using your unit, and a complete description of your station.

NOTES

APPENDIX

-At the MFJ factory, the interface is set for Yaesu transceivers with **modular** microphone connectors (FT-817, FT-857, FT-897).

Icom IC-703
IC-706
(modular)

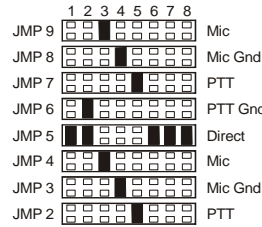

Icom IC-718
IC-725
IC-746
IC-756
(8-pin round)

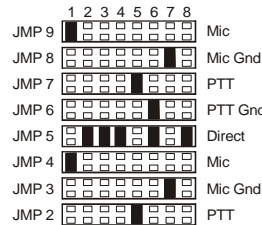

Kenwood TS-50
TS-570
TS-870
TS-2000
(8-pin round)

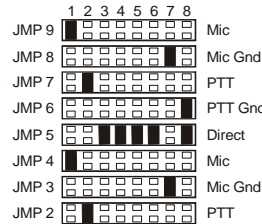

Kenwood TS-480
(modular)

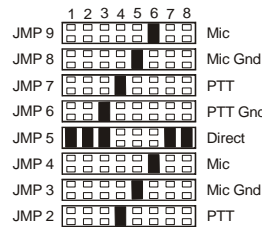

Yaesu FT-817
FT-857
FT-897
(modular)

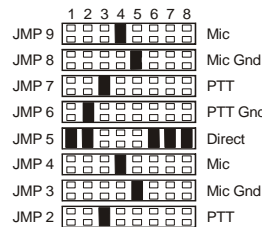

Yaesu FT-847
(8-pin round)

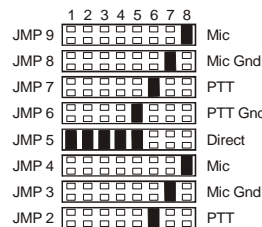

Schematic

